

Tret Up

design: arch.Margarita Kroucharska_Gianni Forcolini

GHIDINI
LIGHT DESIGN

Tret Up illumina percorsi pedonali in aree pubbliche e residenziali. Il design è sobrio ed essenziale, adeguato a inserimenti armonici nel contesto ambientale. La linea è costituita da elementi realizzati in alluminio pressofuso ed estruso. La possibilità di accostarli in soluzioni differenti, in cui si fondono, nella forma, le sensazioni trasmesse dai diversi materiali, consente di ottenere risultati estetici personalizzati e unici. Disponibile nella versione anti-inquinamento luminoso.

Tret Up is made of die-cast aluminium. An organically shaped column mounted light with internal anti-glare louvre for use in public paths, pedestrian areas, parks or architectural applications. Available for a round or triangular column. Wood effect finish available in addition to many different finishes. Accessories available include an anchorage base. Light performance in accordance with indirect light control emission regulations.

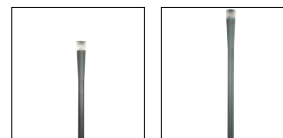

CERTIFICAZIONI CERTIFICATION



LEDLAB GHIDINITM

versioni led disponibili: 3000 K / 4000 K
LEDs available: 3000 K / 4000 K

GRADO DI PROTEZIONE
IP / IK RATING

IP 65 / IK 10
IP 65 / IK 10

CLASSE DI ISOLAMENTO
CLASSIFICATION

classe I  classe II su richiesta
class I  class II upon request

CORPO
BODY

alluminio fuso EN AC 44200 alta resistenza all'ossidazione
cast aluminium EN AC 44200 high resistance to oxidation

PALO
COLUMN

alluminio estruso EN AW 6060 alta resistenza all'ossidazione
extruded aluminium EN AW 6060 high resistance to oxidation

DIFFUSORE
DIFFUSER

poli-carbonato trasparente resistente all'urto e ai raggi UV
vandal proof clear polycarbonate UV resistant

VITERIA ESTERNA

EXTERNAL FIXINGS

inox A4-70 trattata in soluzione lubrificante idrorepellente con alto potere antiossidante. Il trattamento assicura la facile apertura del prodotto durante la manutenzione
stainless steel A4-70 treated with highly antioxidant water-repellent lubricating solution. The treatment ensures easy opening of the product for maintenance

GUARNIZIONI
SEALING GASKET

silicone ricotto
silicone

CABLAGGIO
WIRING

apparecchio fornito con 3,2m di cavo H07RN8-F pre cablato
fixture supplied pre-wired cable 3.3m long H07RN8-F

LAMPADINA
LAMP

esclusa (Led incluso)
not included (Led integral)

FINITURA

FINISH

verniciatura in polveri poliestere ad alta resistenza ai raggi UV ed alla corrosione
powder coating polyester high resistance to UV and oxidation

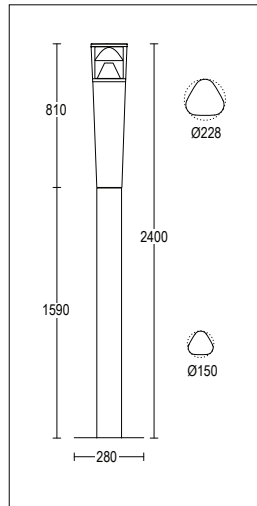

- IP65 codice colori
colour codes
- .05** grigio antracite
anthracite grey
- .13** grigio chiaro
light grey
- IK10
- classe II su richiesta
class II upon request

8280.CDF.T.-- 39 W 1 Led 3000 K 3765 lm
8280.CHF.T.-- 39 W 1 Led 4000 K 3932 lm
 220-240 V 50/60 HZ
 Policarbonato trasparente *clear polycarbonate*
 alimentatore incluso *led driver integral*

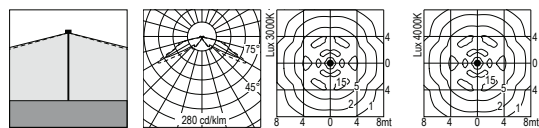

8280.19F.T.-- 70 W HIT G12 6600 lm
 230 V 50 HZ
 policarbonato trasparente *clear polycarbonate*
 alimentatore ferromagnetico incluso
conventional ballast integral

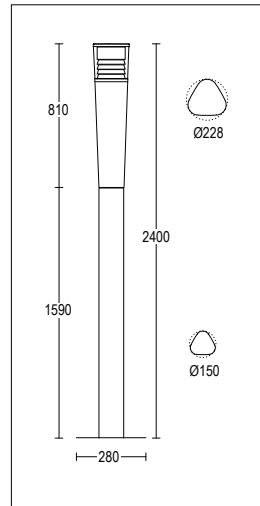
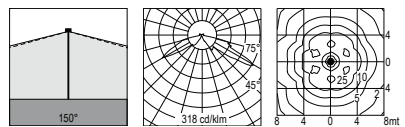

- IP65 codice colori
colour codes
- .05** grigio antracite
anthracite grey
- .13** grigio chiaro
light grey
- IK10
- classe II su richiesta
class II upon request
- *

8282.19F.T.-- 70 W HIT G12 6600 lm
 230 V 50 HZ
 policarbonato trasparente *clear polycarbonate*
 alimentatore ferromagnetico incluso
conventional ballast integral

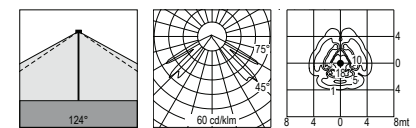

Accessori Accessories

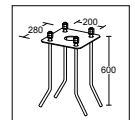

429
 Base di ancoraggio + tiranti da cementare
Plated steel anchorage for concreting

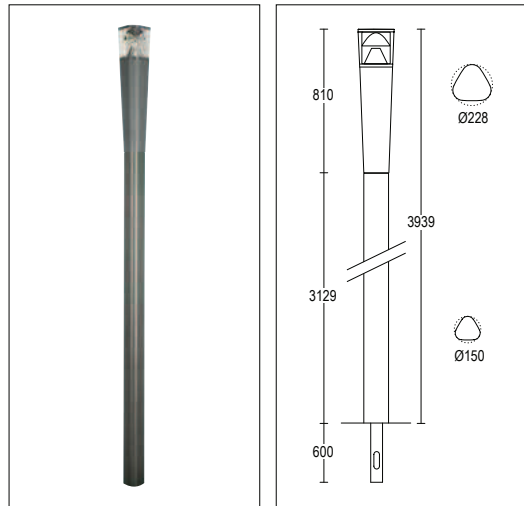

IP65 codice colori
colour codes

.05 grigio antracite
anthracite grey

.13 grigio chiaro
light grey

IK10

classe II su richiesta
class II upon request

8284.CDF.T.-- 39 W 1 Led 3000 K 3765 lm
8284.CHF.T.-- 39 W 1 Led 4000 K 3932 lm
 220-240 V 50/60 HZ
 Policarbonato trasparente *clear polycarbonate*
 alimentatore incluso *led driver integral*

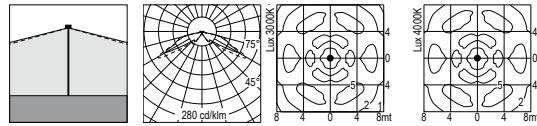

8284.19F.T.-- 70 W HIT G12 6600 lm
 230 V 50 HZ
 Policarbonato trasparente *clear polycarbonate*
 alimentatore ferromagnetico incluso
conventional ballast integral

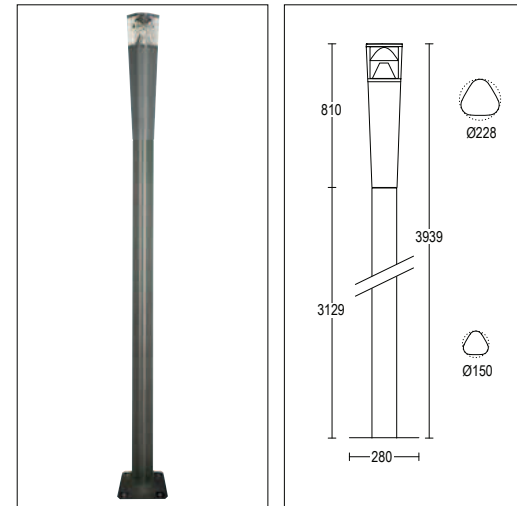
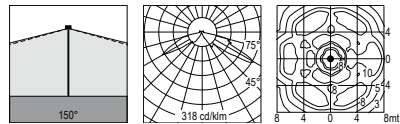

IP65 codice colori
colour codes

.05 grigio antracite
anthracite grey

.13 grigio chiaro
light grey

IK10

classe II su richiesta
class II upon request

8285.CDF.T.-- 39 W 1 Led 3000 K 3765 lm
8285.CHF.T.-- 39 W 1 Led 4000 K 3932 lm
 230 V 50 HZ
 Policarbonato trasparente *clear polycarbonate*
 alimentatore incluso *led driver integral*

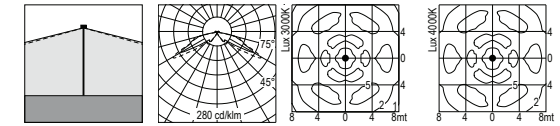

8285.19F.T.-- 70 W HIT G12 6600 lm
 230 V 50 HZ
 Policarbonato trasparente *clear polycarbonate*
 alimentatore ferromagnetico incluso
conventional ballast integral

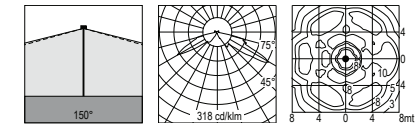

Accessori Accessories

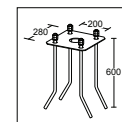

429
 Base di ancoraggio + tiranti da cementare
Plated steel anchorage for concreting